

Product Summary

Symbol	Value	Unit
$I_{T(RMS)}$	1.0	A
$V_{DRM} V_{RRM}$	600 / 800	V
I_{GT}	100	μA

Feature

With high ability to withstand the shock loading of large current, Provide high dv/dt rate with strong resistance to electromagnetic interference.

Application

Power charger, T-tools, massager, solid state relay, AC Motor speed regulation and so on.

Package

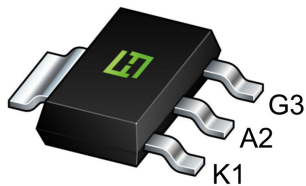

SOT-223-3L

Circuit diagram

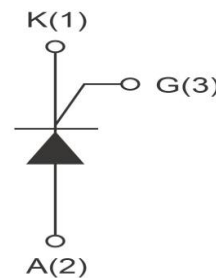

Marking

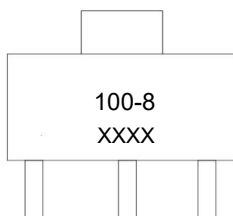

Absolute maximum ratings (Ta=25°C unless otherwise noted)

Parameter	Symbol	Value	Unit
Repetitive peak off-state voltage	V_{DRM}	600 / 800	V
Repetitive peak reverse voltage	V_{RRM}	600 / 800	V
RMS on-state current	$I_{T(RMS)}$	1.0	A
Non repetitive surge peak on-state current (full cycle, F=50Hz)	I_{TSM}	12	A
I^2t value for fusing (tp=10ms)	I^2t	0.72	A ² s
Critical rate of rise of on-state current ($I_G = 2 \times I_{GT}$)	di_T/dt	50	A/ μ s
Peak gate current	I_{GM}	0.5	A
Average gate power dissipation	$P_{G(AV)}$	0.1	W
Junction Temperature	T_J	-40 ~ +110	°C
Storage Temperature	T_{STG}	-40 ~ +150	°C

Electrical characteristics (TA=25°C, unless otherwise noted)

Parameter	Symbol	Test Condition	Value		Unit	
			Min	Max		
Gate trigger current	I_{GT}	$V_D = 12V I_T = 10mA T_J = 25^\circ C$	-	100	μA	
Gate trigger voltage	V_{GT}		-	0.8	V	
Gate non-trigger voltage	V_{GD}	$V_D = 1/2 V_{DRM} T_J = 110^\circ C$	0.2	-	V	
latching current	I_L	$V_D = 12V I_G = 0.5mA$ $R_{GK} = 1k\Omega T_J = 25^\circ C$	-	5	mA	
Holding current	I_H		-	4	mA	
Critical-rate of rise of commutation voltage	dV_D/dt	$V_D = 2/3 V_{DRM}$ Gate Open $T_J = 110^\circ C$	50	-	V/ μ s	
STATIC CHARACTERISTICS						
Forward "on" voltage	V_{TM}	$I_{TM} = 2A t_p = 380\mu s$	-	1.7	V	
Repetitive Peak Off-State Current	I_{DRM}	$V_D = V_{DRM} V_R = V_{RRM}$	$T_J = 25^\circ C$	-	5	μA
Repetitive Peak Reverse Current	I_{RRM}		$T_J = 110^\circ C$	-	0.1	mA
THERMAL RESISTANCES						
Thermal resistance	$R_{th(j-c)}$	Junction to case	TYP.	20	°C/W	
	$R_{th(j-a)}$	Junction to ambient	TYP.	60	°C/W	

Typical Characteristics

FIG1 Maximum power dissipation versus RMS on-state current

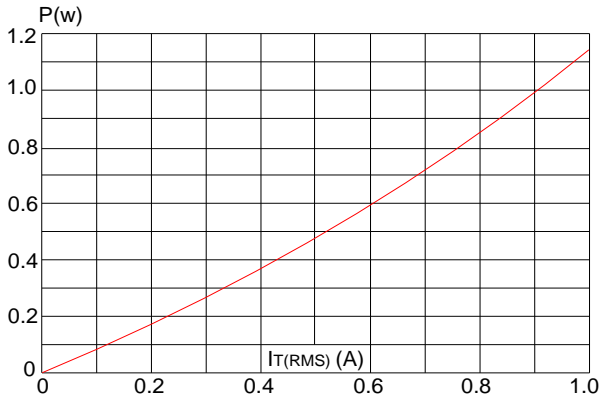

FIG2 RMS on-state current versus case temperature

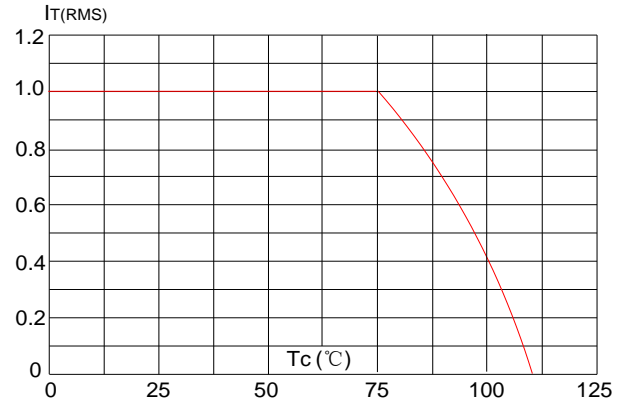

FIG3 Surge peak on-state current versus number of cycles

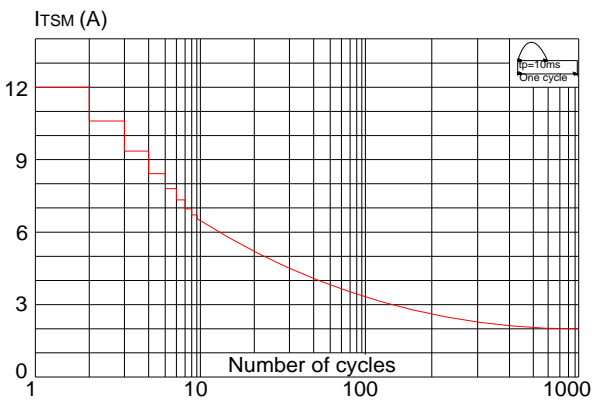

FIG4 On-state characteristics (maximum values)

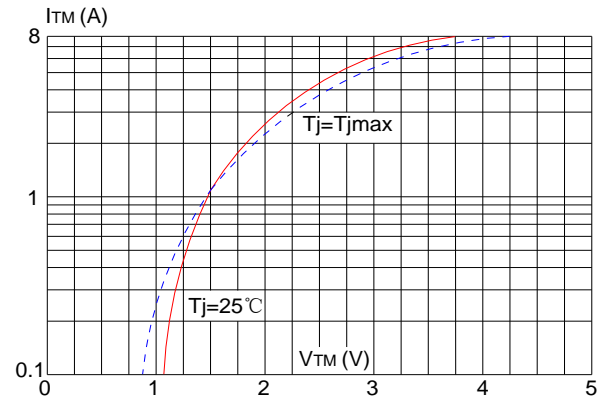

FIG5 Non-repetitive surge peak on-state current for a sinusoidal pulse with width $t_p < 20\text{ms}$, and corresponding value of I^2t ($di/dt < 100\text{A}/\mu\text{s}$)

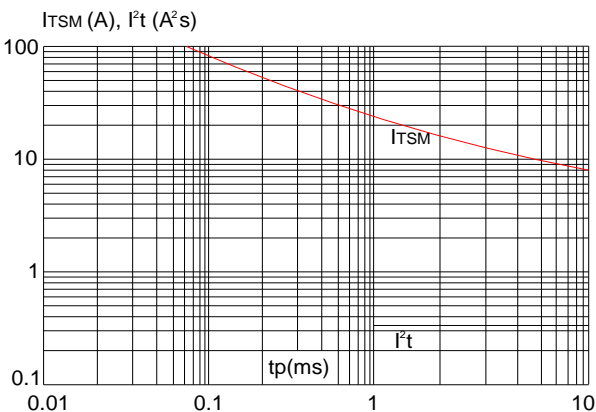
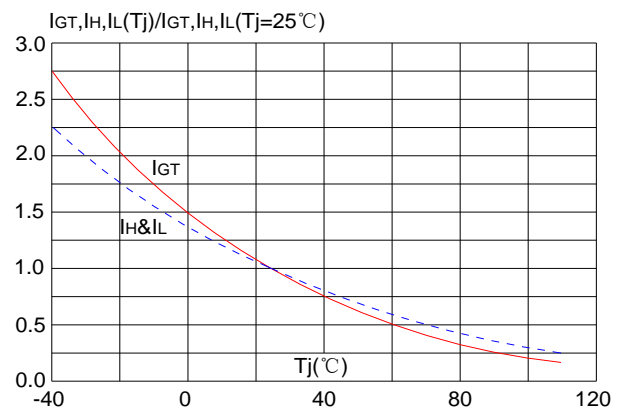
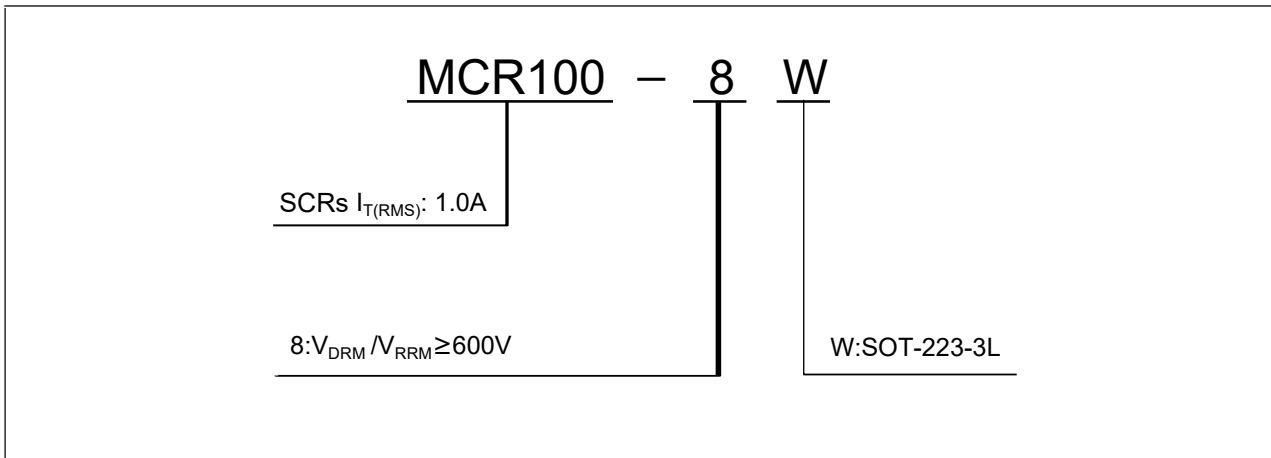

FIG6 Relative variations of gate trigger current, holding current and latching current versus junction temperature



Ordering Information



SOT-223-3L Package Information

